

Ø 12-168,3 mm



SYSTEM **KAN-therm**

Inox

Fine Material
Ultra possibilities

EN 2015



TECHNOLOGY OF SUCCESS



ISO 9001



About KAN

Innovative water and heating solutions

KAN was established in 1990 and has been implementing state of the art technologies in heating and water distribution solutions ever since.

KAN is a European recognized leader and supplier of state of the art KAN-therm solutions and installations intended for indoor hot and cold tap water installations, central heating and floor heating installations, as well as fire extinguishing and technological installations. Since the beginning of its activity, KAN has been building its leading position on such values as professionalism, innovativeness, quality and development. Today, the company employs over 600 people, a great part of which are specialist engineers responsible for ensuring continuous development of the KAN-therm system, all technological processes applied and customerservice. The qualifications and commitment of our personnel guarantees the highest quality of products manufactured in KAN factories.

Distribution of the KAN-therm system is performed through a network of commercial partners all over Poland, Germany, Russia, Ukraine, Belarus, Ireland, the Czech Republic, Slovakia, Hungary, Romania and in the Baltic States. Our expansion and dynamic development has proven so effective that KAN-therm labeled products are exported to 23 countries, and our distribution network assumes Europe, a great part of Asia, and a part of Africa.

The KAN-therm system is an optimal, complete multipurpose installation system consisting of state of the art, mutually complementary technical solutions for pipe water distribution installations, heating installations, as well as technological and fire extinguishing installations. It is the materialization of a vision of a universal system, the fruit of extensive experience, the passion of KAN's constructors, as well as strict quality control of our materials and final products.



SYSTEM KAN-therm
- special award:
Pearl of the highest quality
and:
Golden Quality International Medal
2015, 2014 i 2013.

TECHNOLOGY OF SUCCESS



Table of contents

3	KAN-therm Inox System
4	Advantages
5	Application
6	Pipes
7	Fittings
8	Tools
9	Assembly
10	Additional information
11	Past projects

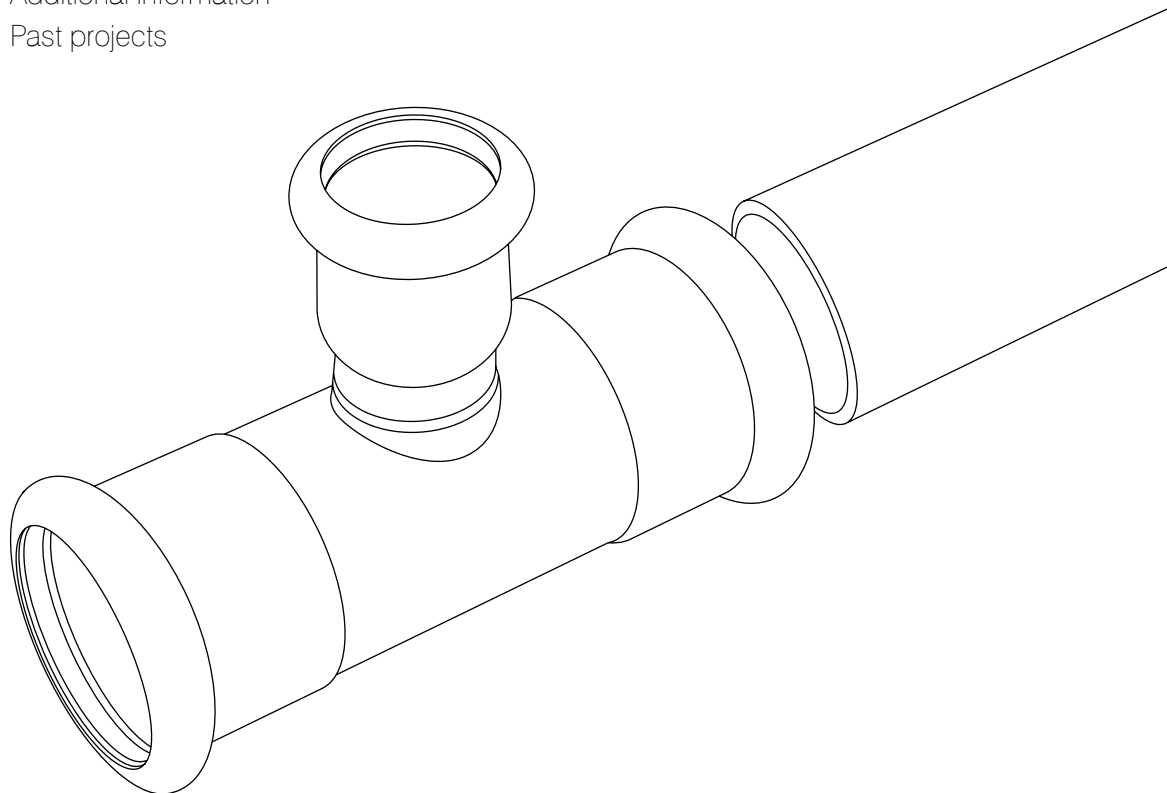

SYSTEM **KAN-therm**

Inox

KAN-therm Inox is a complete, state of the art installation system consisting of stainless steel pipes and fittings. The “press” technology applied in the KAN-therm System allows for performing fast and tight joints by pressing them using generally available crimping profiles, eliminating the need to thread or weld particular system elements. Thanks to this solution the process of assembling an installation, even with large-diameter pipes and fittings, is reduced to the absolute minimum.

Due to the material specification of the system as well as an extensive range of diameters, the KAN-therm Inox system is suitable for constructing complete, indoor heating and cooling installations, as well as tap water installations in single- and multi-family buildings, as well as public buildings.

High resistance to material corrosion and a broad scope of operating pressures and temperatures makes the system ideal for performing compressed air, solar, technological and industrial installations of any purpose.

Advantages

- **material for years to come**

The durability of stainless steel materials is unmatched by any other materials applied in the production of pipe installations. Their operating properties and appearance do not change over the years.

- **highest quality and esthetic**

Stainless steel is a very durable and practical, as well as fine and elegant material. Thanks to the diversity of types and a wide range of products, it satisfies even the most demanding expectations of the construction and finishing industry, expressed by architects and interior decorators all over the world.

- **ecology**

Stainless steel is generally applied in the production of devices having contact with potable water, since it is safe for human health and the environment. By applying stainless steel elements, we avoid the need to use paint or other anticorrosive coatings, which are not neutral for the natural environment or the human health.

- **high resistance to corrosion**

Stainless steel is an iron alloy with at least 11% of chromium contents. Stainless steel acquires its anticorrosive effect thanks to a surface layer of chromium oxides, which is very durable and, even in the case of mechanic or chemical damages to steel surface, it immediately recovers, thanks to which the anticorrosive properties of the material are maintained.

- **durability and universal application**

Thanks to the use of high quality sealants in the fitting structure, the system will work at -35°C to +230°C (depending on the type of sealant used). Application of the "Press" assembly technology as well as professional pressing tools provides the system with resistance to pressures of up to 16 bar. Such impressive pressure resistance makes the system suitable for multiple applications, beginning with small installations in single-family housing buildings, and ending with extensive, specialized industrial installations.

- **"giga" hydraulics**

KAN-therm Inox is one of few systems on the market to offer "GIGA SIZE" diameters of 139.7 and 168.3 mm in their product range. These diameters allow for achieving very high flow capacities. Special structure of the elements eliminates the narrowing in the cross-section of the pipe-fitting joint (the bottleneck effect), which secures the installation against excessive local losses



Application



The system is designed for constructing new, complete (risers and horizontal feeding pipes), **indoor-use heating installations** as well as **hot and cold tap water installations** in multi-family housing buildings.

Due to the highest quality of material used in the production of pipes and fittings (stainless steel), the KAN-therm Inox System is particularly recommended for performing installations in high-standard construction projects or investments requiring a high cleanliness standard, such as e.g. heating or tap water installations in hospitals, laboratories, medical offices, etc.

Low thermal elongation of pipes and esthetic appearance of finished system elements make the system ideal for on-plaster heating and tap water installations. KAN-therm Inox is the perfect alternative for renovating old, historical buildings which do not offer the possibility of placing the installation in structural partitions.

After consulting with KAN's Technical Department, there is a possibility of applying the system in non-standard installations, such as:

- **compressed air**
- **solar installations**
- **industrial installations**
- **technological installations**
- **hydrant installations**
- **steam installations**



Pipes

Fine material

The KAN-therm Inox range offers seamed pipes, made of thin-walled stainless steel:

- Corrosion-resistant chromium-nickel-molybdenum steel X2CrNiMo17-12-2, no. 1.4404, according to DIN-EN 10088, manufactured according to DIN 17455, according to AISI 316L.
- Corrosion-resistant chromium-molybdenum-titanium steel X2CrMoTi18-2, no. 1.4521, according to DIN-EN 10088, manufactured according to DIN 17455, according to AISI 316L.

Pipe diameters

- 1.4404 stainless steel pipes: 12 – 168,3mm (pipe wall thickness: from 1.0mm to 2.0mm)
- 1.4521 stainless steel pipes: 15 – 54mm (pipe wall thickness: from 1.0mm to 1.5mm)

The pipes are characterized by low thermal elongation coefficient, which facilitates compensation for the entire installation.

Material type	Linear elongation coefficient	Elongation with temperature increase by 60°C at 4m	Thermal conductivity
	[mm/m × K]	[mm]	[W/(m ² × K)]
Inox	0,0160	3,84	15

GIGA Size – “GIGA” possibilities

GIGA Size diameters 139 and 168 mm allow for applying system elements for constructing pipe installations requiring very high flow capacities, usually found in large-cubature construction projects.



Fittings

High quality and esthetic

KAN-therm Inox System fittings are made of anticorrosive chromium-nickel-molybdenum steel X2CrNiMo17-12-2 (stainless steel) no. 1.4404, according to DIN-EN 10088, manufactured according to DIN 17455, according to AISI 316L.

KAN-therm Inox fittings are offered in the 15-168.3mm diameter range.

The "press" technology applied in the KAN-therm System allows for performing fast and tight joints by pressing them using generally available crimping profiles, eliminating the need to thread or weld particular system elements. Thanks to this solution, the process of assembling an installation, even with large-diameter pipes and fittings, is reduced to the absolute minimum. This technology guarantees highest quality and tightness, as well as impressive esthetic of the entire installation.



- 1. Cross-section of a joint before pressing
- 2. Cross-section of the joint after pressing

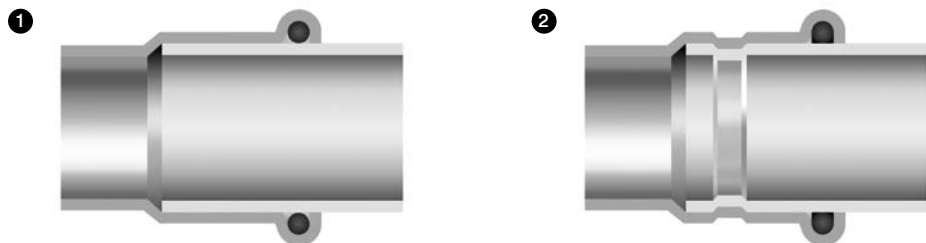

Joining system elements in the "Press" technology allows for acquiring joints with minimum pipe cross-section narrowing, which considerably reduces pressure loss in the entire installation and produces excellent hydraulic conditions.

- 3. Four-point grip in the KAN-therm Inox system.

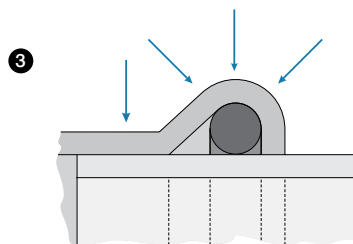



Tightness and reliability of joints in the KAN-therm Inox System is guaranteed by special O-ring seals and the four-point type "M" grip system.

O-rings

Durability and universal application

KAN-therm Inox System fittings are, by standard, equipped with special O-rings. Depending on the required operating parameters for the system and the type of medium transported, fittings may be equipped with three types of O-rings: EPDM (factory-mounted), FPM/Viton (green – replaced by the client) and FPM/Viton (gray – replaced by the client).

O-ring name	Properties and operating parameters	Application
EPDM (ethylene-propylene rubber)	 <p>diameter range: 12–108 mm color: black max operating pressure: 16 bar operating temperature: -35 °C to 135 °C short-term: 150 °C</p> <p>diameter range: 139–168,3 mm max operating pressure: 16 bar working temperature: -20 °C to 110 °C</p>	<p>potable water hot water conditioned water (softened, decalcinated, distilled, with glycol) compressed air (no oil)</p>
FPM/Viton (fluoride rubber)	 <p>diameter range: 12–168,3 mm color: green max operating pressure: 16 bar operating temperature: -30 °C to 200 °C short-term: 230 °C</p>	<p>solar installations (glycol) compressed air fuel oil vegetable fat engine fuels</p> <p>Notice: do not use in potable water and pure hot water installations.</p>
FPM/Viton fluoride rubber	 <p>diameter range: 15–54 mm color: gray max operating pressure: 5 bar operating temperature: -20 °C to 150 °C short-term: 180 °C</p>	<p>steam installations</p>

All KAN-therm Inox System fittings offer the LBP function (signaling of ill-pressed joints, LBP – Leak Before Press). Ill-pressed joints are not water-tight and thus easy to locate.

1. O-ring action with the LBP function of leakage detection



2. LBP O-rings with a function of leakage detection

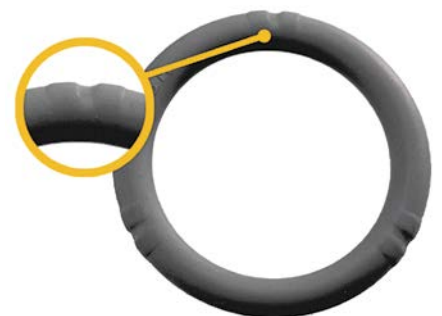

For higher diameters, the LBP function is performed by specially structured O-rings, equipped with special furrows, which ensure full and optimal control over the joints during pressure tests.

In the 76.1-108mm diameter range, the LBP function is performed by a increase of the internal diameter of the fitting in relation to the external diameter of the pipe.

Tools

Professionalism and safety

KAN-them Inox is not only pipes and fittings, but also a wide range of professional, advanced tools for safe and secure performance of element joints.

Our offer includes electrical or battery-powered tools designed by renowned companies, the selection of which depends on the diameter of the pipes assembled.

REMS Tools

- 1. Aku Press
- 2. Power Press SE.
- 3. M12-54mm jaws



KLAUKE Tools

- 4. UAP 100 press
- 5. KSP3 76-108mm jaws



NOVOPRESS Tools

- 6. ECO 301 press
- 7. M12-28mm jaws
- 8. HP 35 Snap On jaws
- 9. HP 42, HP 54 Snap On jaws
- 10. ZB 303 adapter



- 11. ACO 401 press
- 12. HP 76.1 – 168.3 jaws



— devices for preliminary treatment



Easy and quick assembly

Joining KAN-therm Inox System elements is performed utilizing a simple, fast and, most importantly, safe (no work is performed with open flames) "Press" technique, based on pressing the fitting on the pipe using special crimping profiles.

All tools designed for use with the KAN-therm Inox System are easy to use and do not require any special licenses to operate.

1. Pipe cutting using special rotary cutters – cut perpendicularly to the pipe

a. – for diameters of up to 54mm, inclusive

b. – for diameters above 54 mm

2. Chamfering the external and internal surface of the pipe end using special chamfers or files

a. – for diameters of up to 54mm, inclusive

b. – for diameters above 54 mm

3. Marking the required pipe insertion depth – necessary for obtaining proper joint tightness

4. Inspection for the presence of O-ring in the fitting

5. Insertion of the pipe into the fitting to the required depth

6. Placement of jaws on the fitting and pressing

a. – for diameters of up to 54mm, inclusive

b. – for diameters above 54 mm



Certificates

High quality of KAN-therm Inox System elements is guaranteed by Polish and foreign certifying bodies:



Past projects

All our past projects performed in the KAN-therm Inox System, both in Poland and abroad are the ideal confirmation of the highest quality of our products:

1. National Stadium – Warsaw, Poland.



2. Jagiellonian Innovation Center – Kraków, Poland.

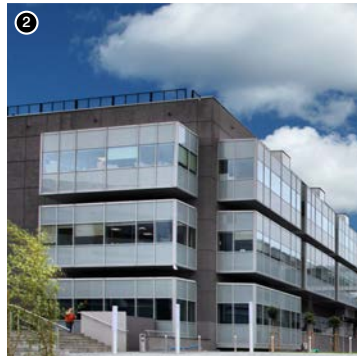

3. Bolshoi Theater – Moscow, Russia.

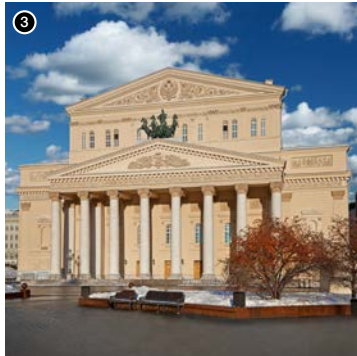

4. Housing buildings - Minsk, Belarus.

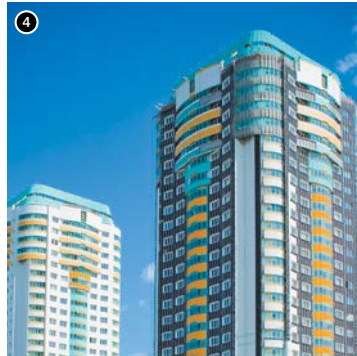

5. Hilton Hotel – Warsaw, Poland.



6. Gdańsk University, Faculty of Social Sciences – Gdańsk, Poland.



7. The Royal Castle - Warsaw, Poland.



8. Axel Springer Building – Berlin, Germany.

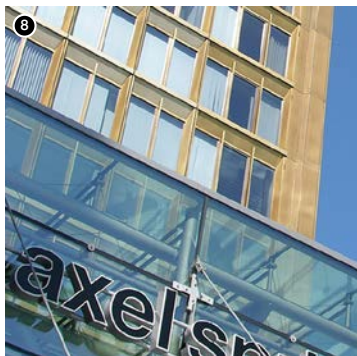

9. Modern Hospital complex – Glasgow, Scotland.



SYSTEM **KAN-therm**

Optimal, complete multipurpose installation system consisting of state of the art, mutually complementary technical solutions for pipe water distribution installations, heating installations, as well as technological and fire extinguishing installations.

It is the materialization of a vision of a universal system, the fruit of extensive experience, the passion of KAN's constructors, strict quality control of our materials and final products, and vast knowledge of the market of installations to meet the requirements of energy efficient, sustainable construction.

	Push Platinum	
	Push	
	Press LBP	
	PP	
	Steel	
	Inox	
	Sprinkler	
	Underfloor heating and automation	
	Football Stadium installations	
	Cabinets and manifolds	



KAN Sp. z o.o.
ul. Zdrojowa 51, 16-001 Białystok-Kleosin
tel. +48 85 74 99 200, fax +48 85 74 99 201
e-mail: kan@kan-therm.com

www.kan-therm.com